

Owner's Manual

Please read before using this unit.

DVD/CD Player

SWD71V5SK

Symphonic

INSTRUCCIONES EN ESPAÑOL INCLUIDAS.

Setting the Main Unit

You can install this unit horizontally or vertically. Attach the Foot to the bottom of the unit (for Horizontal installation) or bottom of the Stand (for Vertical installation).

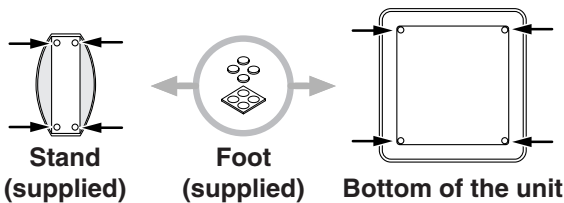

Horizontal installation (laying position):

Place the unit as [POWER] comes on your right.

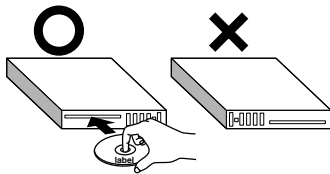

Hint

• Insert a disc with the label facing up.

Vertical installation (standing position):

Place the unit as its dent matches the catch of the Stand. As you position the unit be sure [POWER] is located at the top.

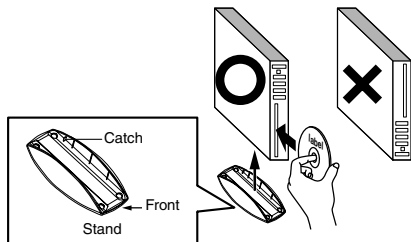

Hint

• Insert a disc with its label facing to the left.

If you need additional operating assistance after reading this owner's manual, please call
TOLL FREE : 1-800-242-7158
or visit our web site at <http://www.Symphonic.us>

Table of Contents

Precautions

Laser Safety	2
■ Important Safeguards	3
Supplied Accessory	4
Installation Location	4
About Copyright	4
Avoid the Hazards of Electrical Shock and Fire	4
Moisture Condensation Warning	4
Symbols Used in This Manual	4
Maintenance	4
■ About the Discs	5
Playable Discs	5
Unplayable Discs	5

Setup

■ Connections	6
Connection to a TV	6
Connection to RF Modulator	6
Connection to an Audio System	7
Rear Terminals	7
■ About the Remote Control	8
Remote Control	8
Installing the Batteries for the Remote Control	8

Functions

■ Playback	9
■ MP3/WMA Playback	10
■ On-Screen Display	10
■ Search Function	11
Track Search	11
Title / Chapter Search	11
Time Search	11
■ Marker Setup	11
■ Repeat / Random / Programmed Playback	12
Repeat Playback	12
Repeat A-B Playback	12
Random Playback	12
Programmed Playback	12
■ Special Settings	13
Subtitle Language	13
Audio Language	13
Camera Angles	13
Black Level Setting	13
Stereo Sound Mode	13
Virtual Surround	13
■ DVD Setup	14
LANGUAGE Setting	14
DISPLAY Setting	15
AUDIO Setting	15
PARENTAL Setting	16
OTHERS Setting	16
Reset to the Default Setting (Except for PARENTAL Setting)	17

Information

■ Troubleshooting Guide	17
■ Specifications	18
■ Language Code List	18
■ Limited Warranty	18
Español	19

Quick Use Guide Back Cover

5 inch
Disc ONLY

Precautions

Setup

Functions

Information

Español

Precautions

WARNING: TO REDUCE THE RISK OF FIRE OR ELECTRIC SHOCK, DO NOT EXPOSE THIS APPLIANCE TO RAIN OR MOISTURE.



CAUTION
RISK OF ELECTRIC SHOCK
DO NOT OPEN



The lightning flash with arrowhead symbol, within an equilateral triangle, is intended to alert the user to the presence of uninsulated "dangerous voltage" within the product's enclosure that may be of sufficient magnitude to constitute a risk of electric shock to persons.



The exclamation point within an equilateral triangle is intended to alert the user to the presence of important operating and maintenance (servicing) instructions in the literature accompanying the appliance.

CAUTION:

TO REDUCE THE RISK OF ELECTRIC SHOCK, DO NOT REMOVE COVER (OR BACK). NO USER SERVICEABLE PARTS INSIDE. REFER SERVICING TO QUALIFIED SERVICE PERSONNEL.

Laser Safety

This unit employs a laser. Only a qualified service person should remove the cover or attempt to service this device, due to possible eye injury.

CAUTION: USE OF CONTROLS OR ADJUSTMENTS OR PERFORMANCE OF PROCEDURES OTHER THAN THOSE SPECIFIED HEREIN MAY RESULT IN HAZARDOUS RADIATION EXPOSURE.

CAUTION: VISIBLE AND INVISIBLE LASER RADIATION WHEN OPEN AND INTERLOCK DEFEATED. DO NOT STARE INTO BEAM.

LOCATION: INSIDE, NEAR THE DECK MECHANISM.

FCC WARNING- This equipment may generate or use radio frequency energy. Changes or modifications to this equipment may cause harmful interference unless the modifications are expressly approved in the manual. The user could lose the authority to operate this equipment if an unauthorized change or modification is made.

RADIO-TV INTERFERENCE

This equipment has been tested and found to comply with the limits for a Class B digital device, pursuant to Part 15 of the FCC Rules. These limits are designed to provide reasonable protection against harmful interference in a residential installation. This equipment generates, uses, and can radiate radio frequency energy and, if not installed and used in accordance with the instructions, may cause harmful interference to radio communications. However, there is no guarantee that interference will not occur in a particular installation. If this equipment does cause harmful interference to radio or television reception, which can be determined by turning the equipment off and on, the user is encouraged to try to correct the interference by one or more of the following measures:

- 1) Reorient or relocate the receiving antenna.
- 2) Increase the separation between the equipment and receiver.
- 3) Connect the equipment into an outlet on a circuit different from that to which the receiver is connected.
- 4) Consult the dealer or an experienced radio/TV technician for help.

This Class B digital apparatus complies with Canadian ICES-003.

Cet appareil numérique de la classe B est conforme à la norme NMB-003 du Canada.

CAUTION: TO PREVENT ELECTRIC SHOCK, MATCH WIDE BLADE OF PLUG TO WIDE SLOT, FULLY INSERT.

ATTENTION: POUR ÉVITER LES CHOC ÉLECTRIQUES, INTRODUIRE LA LAME LA PLUS LARGE DE LA FICHE DANS LA BORNE CORRESPONDANTE DE LA PRISE ET POUSSER JUSQU'AU FOND.

A NOTE ABOUT RECYCLING

This product's packaging materials are recyclable and can be reused. Please dispose of any materials in accordance with your local recycling regulations.

Batteries should never be thrown away or incinerated but disposed of in accordance with your local regulations concerning chemical wastes.

Make your contribution to the environment!!!

- Used up batteries do not belong in the dust bin.
- You can dispose of them at a collection point for used up batteries or special waste. Contact your council for details.



For Customer Use:

Read carefully the information located at the bottom of this unit and enter below the Model No. and the Serial No. Retain this information for future reference.

Model No. _____

Serial No. _____

IMPORTANT SAFEGUARDS

- 1) Read Instructions - All the safety and operating instructions should be read before the product is operated.
- 2) Retain Instructions - The safety and operating instructions should be retained for future reference.
- 3) Heed Warnings - All warnings on the product and in the operating instructions should be adhered to.
- 4) Follow Instructions - All operating and use instructions should be followed.
- 5) Cleaning - Unplug this product from the wall outlet before cleaning. Do not use liquid cleaners or aerosol cleaners. Use a damp cloth for cleaning.
- 6) Attachments - Do not use attachments not recommended by the product manufacturer as they may cause hazards.
- 7) Water and Moisture - Do not use this product near water - for example, near a bath tub, wash bowl, kitchen sink, or laundry tub; in a wet basement; or near a swimming pool; and the like.
- 8) Accessories - Do not place this product on an unstable cart, stand, tripod, bracket, or table. The product may fall, causing serious injury to a child or adult, and serious damage to the product. Use only with a cart, stand, tripod, bracket, or table recommended by the manufacturer, or sold with the product. Any mounting of the product should follow the manufacturer's instructions, and should use a mounting accessory recommended by the manufacturer.

PORTABLE CART WARNING
(Symbol provided by RETAC)



S3125A
- 9) A product and cart combination should be moved with care. Quick stops, excessive force, and uneven surfaces may cause the product and cart combination to overturn.
- 10) Ventilation - Slots and openings in the cabinet are provided for ventilation and to ensure reliable operation of the product and to protect it from overheating, and these openings must not be blocked or covered. The openings should never be blocked by placing the product on a bed, sofa, rug, or other similar surface. This product should not be placed in a built-in installation such as a bookcase or rack unless proper ventilation is provided or the manufacturer's instructions have been adhered to.
- 11) Power Sources - This product should be operated only from the type of power source indicated on the marking label. If you are not sure of the type of power supply to your home, consult your product dealer or local power company. For products intended to operate from battery power, or other sources, refer to the operating instructions.
- 12) Grounding or Polarization - This product may be equipped with a polarized alternating-current line plug (a plug having one blade wider than the other). This plug will fit into the power outlet only one way. This is a safety feature. If you are unable to insert the plug fully into the outlet, try reversing the plug. If the plug should still fail to fit, contact your electrician to replace your obsolete outlet. Do not defeat the safety purpose of the polarized plug.
- 13) Power-Cord Protection - Power-supply cords should be routed so that they are not likely to be walked on or pinched by items placed upon or against them, paying particular attention to cords at plugs, convenience receptacles, and the point where they exit from the product.
- 14) Lightning - For added protection for this product during a lightning storm, or when it is left unattended and unused for long periods of time, unplug it from the wall outlet. This will prevent damage to the product due to lightning and power-line surges.
- 15) Power lines - An outside antenna system should not be located in the vicinity of overhead power lines or other electric light or power circuits, or where it can fall into such power lines or circuits. When installing an outside antenna system, extreme care should be taken to keep from touching such power lines or circuits as contact with them might be fatal.
- 16) Overloading - Do not overload wall outlets, extension cords, or integral convenience receptacles as this can result in a risk of fire or electric shock.
- 17) Object and Liquid Entry - Never push objects of any kind into this product through openings as they may touch dangerous voltage points or short-out parts that could result in a fire or electric shock. Never spill liquid of any kind on the product.
- 18) Servicing - Do not attempt to service this product yourself as opening or removing covers may expose you to dangerous voltage or other hazards. Refer all servicing to qualified service personnel.
- 19) Damage Requiring Service - Unplug this product from the wall outlet and refer servicing to qualified service personnel under the following conditions:
 - a) When the power-supply cord or plug is damaged.
 - b) If liquid has been spilled, or objects have fallen into the product.
 - c) If the product has been exposed to rain or water.
 - d) If the product does not operate normally by following the operating instructions. Adjust only those controls that are covered by the operating instructions as an improper adjustment of other controls may result in damage and will often require extensive work by a qualified technician to restore the product to its normal operation.
 - e) If the product has been dropped or damaged in any way.
 - f) When the product exhibits a distinct change in performance - this indicates a need for service.
- 20) Replacement Parts - When replacement parts are required, be sure the service technician has used replacement parts specified by the manufacturer or have the same characteristics as the original part. Unauthorized substitutions may result in fire, electric shock, or other hazards.
- 21) Safety Check - Upon completion of any service or repairs to this product, ask the service technician to perform safety checks to determine that the product is in proper operating condition.
- 22) Heat - The product should be situated away from heat sources such as radiators, heat registers, stoves, or other products (including amplifiers) that produce heat.

Supplied Accessory

- Remote control (NB073UD) with two AA batteries
- Audio/Video cables (WPZ0102TM015/ WPZ0102LTE01)
- Owner's Manual (1VMN22865)

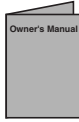
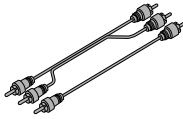
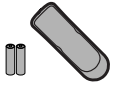

- Speaker unit (USPUSPKHYE06)
- Foot (1 set) (1VM421328)
- Stand (1VM422454)

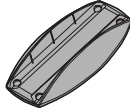
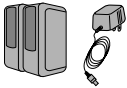

Installation Location

For safety and optimum performance of this unit:

- Do not place anything directly on top of the unit. Do not place the unit directly on top of the TV.
- Shield it from direct sunlight and keep it away from sources of intense heat. Avoid dusty or humid places. Avoid places with insufficient ventilation for proper heat dissipation. Avoid locations subject to strong vibration or strong magnetic fields.
- Be sure to remove the disc and unplug the AC power cord from the outlet before carrying the unit.

About Copyright

Unauthorized copying, broadcasting, public performance and lending of discs are prohibited.

This product incorporates copyright protection technology that is protected by U.S. patents and other intellectual property rights. Use of this copyright protection technology must be authorized by Macrovision, and is intended for home and other limited viewing uses only unless otherwise authorized by Macrovision. Reverse engineering or disassembly is prohibited.

Avoid the Hazards of Electrical Shock and Fire

- Do not handle the power cord with wet hands.
- Do not pull on the power cord when disconnecting it from AC wall outlet. Grasp it by the plug.
- If, by accident, water is spilled on this unit, unplug the power cord immediately and take the unit to our Authorized Service Center for servicing.

Moisture Condensation Warning

Moisture condensation may occur inside the unit when it is moved from a cold place to a warm place, or after heating a cold room or under conditions of high humidity. Do not use this unit at least for 2 hours until its inside gets dry.

“WMA” (Windows Media Audio) is a new audio codec developed by Microsoft® in the United States of America.

Manufactured under license from Dolby Laboratories. “Dolby” and the double-D symbol are trademarks of Dolby Laboratories.

Symbols Used in This Manual

The following symbols appear in some headings in this manual.



: Description refers to playback of DVD-Video discs.



: Description refers to playback of Audio CDs.



: Description refers to playback of Video CDs.



: Description refers to playback of MP3 files.



: Description refers to playback of discs formatted with WMA.

Maintenance

SERVICING

- Please refer to relevant topics on the “Troubleshooting Guide” on page 17 before returning the product.
- If this unit becomes inoperative, do not try to correct the problem by yourself. There are no user-serviceable parts inside. Turn off, unplug the power plug, and please call our help line mentioned on the front page to locate an Authorized Service Center.

CLEANING THE CABINET

- Use a soft cloth slightly moistened with a mild detergent solution. Do not use a solution containing alcohol, spirits, ammonia or abrasive.

CLEANING DISCS

- When a disc becomes dirty, clean it with a cleaning cloth. Wipe the disc from the center to out. Do not wipe in a circular motion.
- Do not use solvents such as benzine, thinner, commercially available cleaners, detergent, abrasive cleaning agents or antistatic spray intended for analog records.

CLEANING THE DISC LENS

- If this unit still does not perform properly although you refer to the relevant sections and to “Troubleshooting Guide” in this Owner's Manual, the laser optical pickup unit may be dirty. Consult your dealer or an Authorized Service Center for inspection and cleaning of the laser optical pickup unit.

DISC HANDLING

- When you handle a disc hold it by its edge and try not to touch the surface of the disc.
- Always store a disc in its protective case when it is not used.
- If the disc's peripheral edge is rough, rub it with pen or pencil stem in order to fine the rough completely. If not, the disc may not be inserted correctly, or the plastic fragments may stick on the disc and cause skips of playback.

About the Discs

Playable Discs

Playable discs	Mark (logo)	Region code	Recorded signals	Disc size	Disc types
DVD-Video * 1, 2, 4, 6, 10		or	Digital video (MPEG2)	5 inches (12 cm)	<p>Example</p> <p>Title 1 Title 2</p> <p>Chapter 1 Chapter 2 Chapter 3 Chapter 4 Chapter 1 Chapter 2</p>
DVD-RW DVD-R * 1, 3, 4, 5, 6, 7, 9, 10		-			
DVD+RW DVD+R * 1, 3, 4, 5, 6, 8, 9, 10		-			
Video CD * 4, 6, 10, 12		-	Digital video with audio	5 inches (12 cm)	<p>Video CD or Audio CD</p> <p>Example</p> <p>Track 1 Track 2 Track 3 Track 4 Track 5 Track 6</p>
Audio CD * 4, 6, 10		-	Digital audio		<p>Example</p> <p>Track 1 Track 2 Track 3 Track 4 Track 5 Track 6</p>
CD-RW CD-R * 4, 5, 6, 9, 10		-	Digital audio or MP3/WMA**11		<p>Example</p> <p>Group 1 Group 2</p> <p>Track 1 Track 2 Track 3 Track 4 Track 5 Track 6</p>

DVD is a trademark of DVD Format/Logo Licensing Corporation.

If you cannot play back a disc which bears one of the marks above, check the following notes.

- *1: This unit conforms to the NTSC color system. Discs recorded in other color systems such as PAL cannot be played back.
 - *2: Certain DVD-Video discs do not operate as described in this manual due to the intentions of the disc's producers.
 - *3: Discs recorded in the VR (Video Recording) format cannot be played back.
 - *4: Scratched or stained discs may not be played back.
 - *5: Some discs cannot be played back because of incompatible recording conditions, characteristics of the recorder or special properties of discs.
 - *6: You can play back discs which bear the marks above. If you use nonstandardized discs, this unit may not play them back. Even if they are played back, the sound or video quality will be compromised.
 - *7: You may play back the unfinalized DVD-R/RW disc recorded in the video format on our brand's DVD recorder. However, depending on the recording status of a disc, the disc may not be played back at all or normally (the picture or sound may not be smooth, etc.). In this case, you need to finalize the disc with the DVD recorder. Refer to the manual accompanying the DVD recorder.
 - *8: Only the discs recorded in the video format and finalized can be played back. Unfinalized discs cannot be played back. Depending on the recording status of a disc, the disc may not be played back at all or normally (the picture or sound may not be smooth, etc.).
 - *9: If there is too much recording space left on a disc (less than 2 3/16 inches (55 mm) across), it may not play back properly.
 - *10: Do not glue paper or put stickers on to the disc. These may damage the disc and the unit may not read it correctly.
 - *11: This DVD/CD player cannot playback the disc contents protected by Windows Media Digital Rights Management (DRM).
 - *12: This unit conforms to ver.1.1 and ver.2.0 of Video CD standard with PBC function.
 - Ver.1.1 (without PBC function) : You can enjoy playback picture as well as music CD.
 - Ver.2.0 (with PBC function) : While using a Video CD with PBC function, "Pbc" appears on the screen.
- NOTE: When playing Video CDs with PBC function, some operations (e.g., track search and repeat tracks) cannot be performed. Cancel PBC function temporarily to perform those operations (refer to page 9).

What is PBC? "PBC" stands for Playback Control.
You can play interactive software using menu screens. Refer to instructions in the Video CD.



Windows Media and the Windows logo are trademarks or registered trademarks of Microsoft Corporation in the United States and/or other countries.
This unit is not compatible with Multiple Bit Rate (MBR: a file that contains the same content encoded at several different bit rates).

Unplayable Discs

- **NEVER play back the following discs. Otherwise, malfunction may result!**
DVD-RAM / CD-i / Photo CD / DVD with region codes other than 1 or ALL / DVD-Audio
DTS-CD / DVD-ROM for personal computers / CD-ROM for personal computers
 - Never insert a disc which is broken or whose form is abnormal (other than 5 inch (12 cm) round disc).
NOTE: Do not use any CD adaptor which covers 3 inch (8 cm) round disc to standard size.
- **On the following disc, the sound MAY NOT be heard.**
Super Audio CD
NOTE: Only the sound recorded on the normal CD layer can be delivered.
The sound recorded on the high density Super Audio CD layer cannot be delivered.
- **Any other discs without compatibility indications**

Setup

Connections

If your TV has AUDIO/VIDEO input jacks, see the following instructions.

Connection to a TV

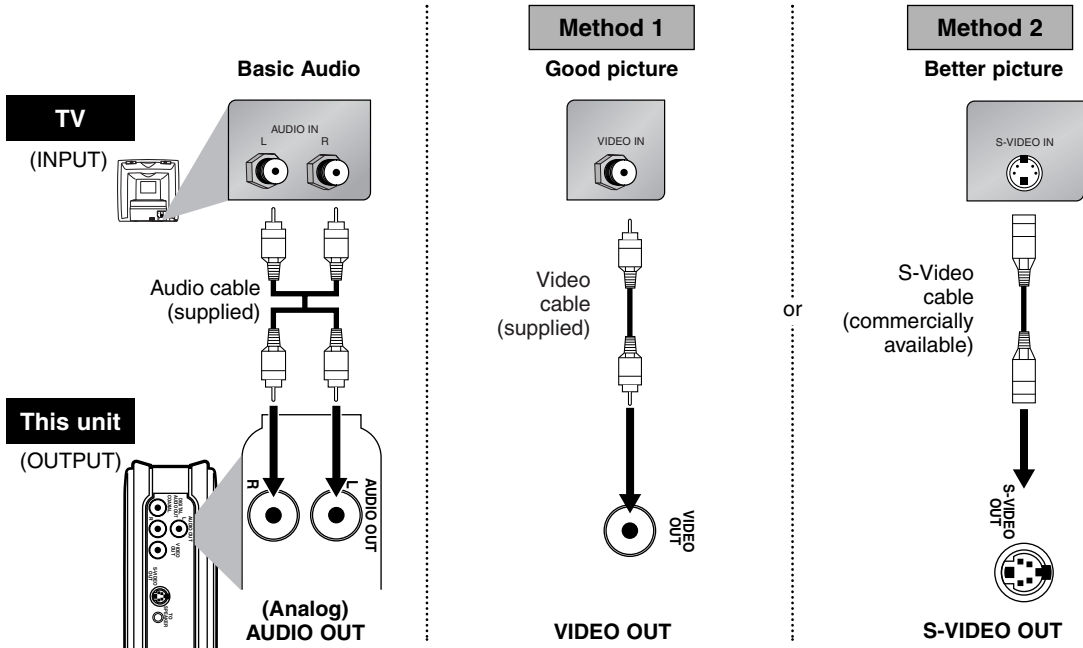

Hint

• Connect this unit directly to the TV. If the Audio/Video cables are connected to a VCR, pictures may be distorted due to the copy protection system.

After you have completed connections

• Press the input selector button (usually TV/VIDEO, INPUT or AUX) on your TV to switch an appropriate external input channel (usually near channel 0) for viewing the picture from this unit. If the picture does not appear, also refer to the manual accompanying your TV.

INPUT MODES FOR COMMON TV BRANDS (Example)

• Listed below are inputs for common brand name TV's.

Admiral: AUX
Curtis Mathis: LINE1, LINE2, 00, 90, 91, 92, 93
GE: INPUT, TV/VCR, 00, 90, 91, 92, 93
Hitachi: INPUT, AUX
JVC: VIDEO, VIDEO1, VIDEO2, VIDEO3
Kenwood: AUX
LXI-Series: 00
Magnavox: AUX CHANNEL

Panasonic: TV/VIDEO
RCA: INPUT, TV/VCR, 00, 90, 91, 92, 93
Samsung: TV/VIDEO
Sanyo: VIDEO
Sharp: 00
Sony: VIDEO1, VIDEO2, VIDEO3
Toshiba: TV/GAME
Zenith: 00

Connection to RF Modulator

If your TV has Antenna in jack only, it is still possible to connect this unit to your TV by using a STEREO AUDIO/VIDEO RF modulator (commercially available).

- 1) Connect the AUDIO/VIDEO output jacks of this unit to the AUDIO/VIDEO input jacks of your RF modulator by audio and video cables.
- 2) The antenna input jack of your TV may have been already occupied. If so, disconnect the RF cable from your TV, and then connect the RF cable to your RF modulator (usually marked "ANT IN").
- 3) Connect your RF modulator to your TV by another RF cable.
- 4) Set your RF modulator's channel 3/4 switch to either 3 or 4, whichever the TV channel is least used in your area. If your RF modulator has a Modulator/Antenna switch, set it according to your RF modulator's manual.
- 5) Turn on your TV and choose the same channel as you set the RF modulator's channel 3/4 switch to. For more details, follow the instructions supplied with the RF modulator.

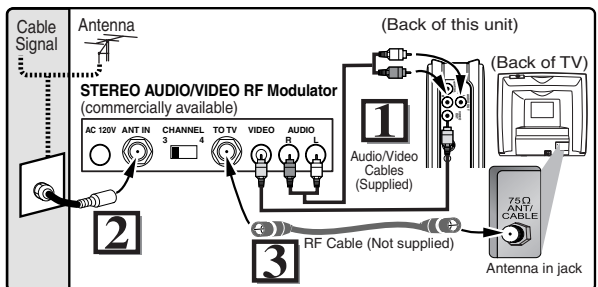

Hint

• The quality of picture may become poor if the unit is connected to an RF modulator.

Connection to an Audio System

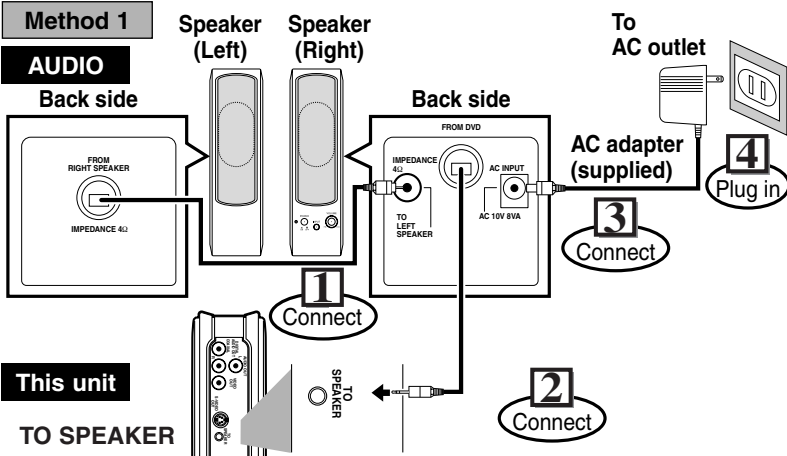

Function Overview for Speaker (Right)

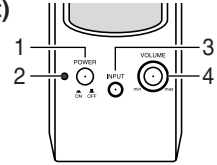

- 1. POWER button**
To turn the speaker on or off.
- 2. POWER light**
Lights up when power is on.
- 3. INPUT jack**
You can connect to the audio out jack of other audio equipment or the headphone jack of a TV.
- 4. VOLUME knob**
To adjust volume.

Hint

- When using the supplied speakers, connect the speakers' AC adapter to the outlet and turn on the power of the supplied speakers.
- The volume of the supplied speakers can be adjusted. Adjust the volume using the volume knob of the right side unit.

Hint

- You can remove the net from front panel of the speakers.
- The INPUT jack is given the priority over the rear connection.

Method 2

AUDIO

Stereo system

Analog audio input jacks

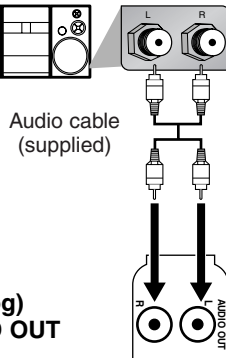

This unit

(Analog)
AUDIO OUT

Setting	SETUP > QUICK >
Connection	DOLBY DIGITAL
Connecting to Stereo System.	PCM

* To complete these settings, refer to pages 14-15.

Hint

- Playing a DVD using incorrect settings may generate noise distortion and may also damage the speakers.

Method 3

AUDIO

Dolby Digital decoder, MD deck or DAT deck

Digital audio input jack

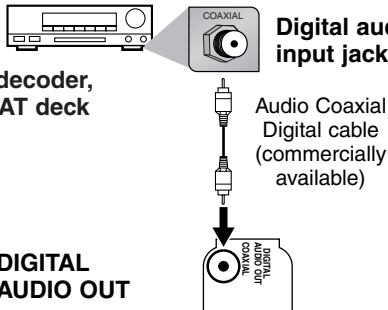

This unit

DIGITAL
AUDIO OUT

Setting	SETUP > QUICK >
Connection	DOLBY DIGITAL
Connecting to a Dolby Digital decoder for Dolby Digital audio output.	BITSTREAM
Connecting to the other equipment (an MD deck or DAT deck etc.) without Dolby Digital decoder.	PCM

* To complete these settings, refer to pages 14-15.

Hint

- The audio source on a disc in a Dolby Digital 5.1 channel surround format cannot be recorded as digital sound by an MD or DAT deck.
- By hooking this unit up to a Multi-channel Dolby Digital decoder, you can enjoy high-quality Dolby Digital 5.1 channel surround sound as heard in the movie theaters.
- Playing a DVD using incorrect settings may generate noise distortion and may also damage the speakers.

Rear Terminals

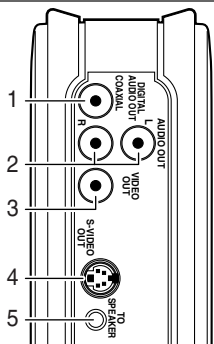

- 1. DIGITAL AUDIO OUT COAXIAL jack**
Connect an optional coaxial digital audio cable here through the coaxial digital audio in jack of a decoder or audio receiver.
- 2. AUDIO OUT jacks**
Connect the supplied audio cable (red/white) here through the audio in jacks of a TV or other audio equipment.

- 3. VIDEO OUT jack**
Connect the supplied video cable (yellow) here through the TV's video in jack.
- 4. S-VIDEO OUT jack**
Connect an optional S-Video cable here through the S-video in jack of a TV.
- 5. TO SPEAKER jack**
Connect the audio cable of the supplied speakers here.

About the Remote Control

Remote Control

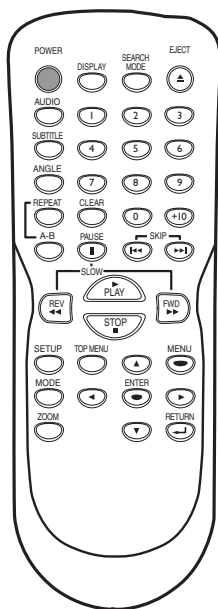

Installing the Batteries for the Remote Control

Install two AA batteries (supplied) matching the polarity indicated inside battery compartment of the remote control.

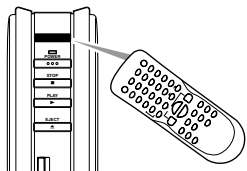
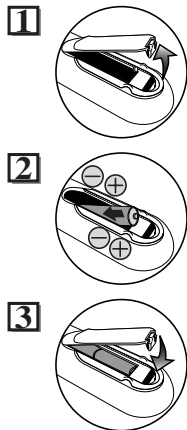

Keep in mind the following when using the remote control:

- Make sure that there is no obstacle between the remote control and the remote sensor on the unit.
- The maximum operable ranges from the unit are as follows.
 - **Beeline:** approx. 23 feet (7m)
 - **Either side of the center:** approx. 16 feet (5m) within 30°
 - **Above:** approx. 16 feet (5m) within 15°
 - **Below:** approx. 10 feet (3m) within 30°

Button (Alphabetical order)	Disc	DVD	CD, MP3, WMA, VCD
1 2 3 4 5 6 7 8 9 0 10		• To select chapter or title directly.	• To select track directly.
ENTER ◀ ▶		• To move the cursor and determine its position.	• To move the cursor and determine its position.
A-B		• To repeat between your chosen point A and B.	• To repeat between your chosen point A and B. (CD/VCD)
ANGLE		• To select camera angles on a disc.	—
AUDIO		• To select audio language on a disc.	• To select STEREO, L-ch or R-ch. (CD/VCD)
CLEAR		• To clear the markers. • To clear the numbers entered incorrectly. • To cancel the point for A-B repeat.	• To clear the markers. (CD/VCD) • To remove status number in program input. • To clear the numbers entered incorrectly. • To cancel the point for A-B repeat. (CD/VCD)
DISPLAY		• To display the current disc mode.	• To display the current disc mode.
EJECT		• Press to remove the disc.	• Press to remove the disc.
REV ▶▶ FWD ◀◀		• To search forward/backward through a disc. • To begin slow forward /reverse playback in the pause mode.	• To search forward/backward through a disc. • To begin slow forward playback during the pause mode. (VCD)
MENU		• To call up the Menu on a disc.	• To call up the file list. (MP3/WMA)
MODE		• To set black level on/off. • To set virtual surround on/off.	• To arrange the playing order or play randomly. (CD/MP3/WMA) • To set virtual surround on/off. • To set black level on/off. (VCD)
PAUSE		• To pause disc playback. • To advance playback one frame at a time.	• To pause disc playback. • To advance playback one frame at a time. (VCD)
PLAY		• To begin disc playback.	• To begin disc playback.
POWER		• To turn the unit on/off.	• To turn the unit on/off.
REPEAT		• To play a chapter or title repeatedly.	• To play a track or disc repeatedly. (CD/VCD) • To play a track, group or disc repeatedly. (MP3/WMA)
RETURN		• To return to the previous operation in menu.	• To return to the previous operation menu.
SEARCH MODE		• To search chapter, title or time. • To set or search the markers.	• To search track. • To search time. (CD/VCD) • To set or search the markers. (CD/VCD)
SETUP		• To call up the DVD setup menu.	• To call up the DVD setup menu.
SKIP		• To skip chapters or titles.	• To skip tracks.
STOP		• To stop playback.	• To stop playback.
SUBTITLE		• To select subtitles on a disc.	—
TOP MENU		• To call up the Top Menu on a disc.	• To return to the top file of the highest hierarchy in the program and file list. (MP3/WMA)
ZOOM		• To magnify part of a picture. (x2/x4)	• To magnify part of a picture. (x2)(VCD)

Functions

Operations described after this section are mainly based on the remote control use. Some operations can be carried out on main unit.

Playback

Before: Turn on the TV, amplifier and any other equipments which are connected to this unit. Make sure the TV and audio receiver (commercially available) are set to the correct channel.

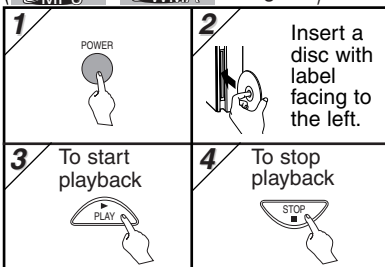

Lights up when power is on.

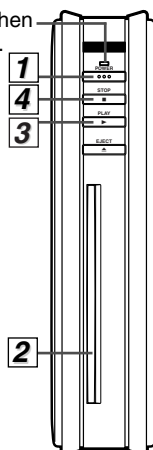
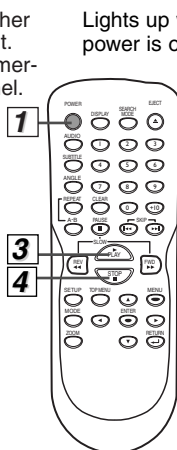

Hint

- When you play an MP3/WMA file, details on page 10.
- A "prohibited icon" may appear at the top-right on the TV screen when the operation is prohibited by the disc or this unit.
- Some DVDs may start playback from title 2 or 3 due to specific programs.
- The operation may vary when you playback DVDs with disc menu or Video CD with PBC. Refer to the manual accompanying the disc for details.
- **During the playback of a two-layered disc, pictures may stop for a moment. This happens while the 1st layer is being switched to the 2nd layer. This is not a malfunction.**

TIP:

You can change the On-Screen language in "PLAYER MENU" setting. (Refer to page 14.)

Canceling and Calling Back PBC Function



- 1) Insert a Video CD and press [STOP ■].
- 2) Press the **Number buttons** to enter the desired track number.
 - PBC function is now cancelled and the playback of the Video CD will start.
- 3) To call back PBC function, press [STOP ■] twice, and then press [PLAY ▶].
 - The title menu will appear on the display.

DVD menu



Some discs contain menus which allow you to customize DVD playback. Press [▲/▼/◀/▶] to select an item, then press [ENTER] (or [PLAY ▶]).

Calling Up a Menu Screen during Playback

- Press [MENU] to call up the DVD menu.
- Press [TOP MENU] to call up the title menu.

Hint

- Menu operations may vary depending on the disc. Refer to the manual accompanying the disc for more details.

Resume



Press [STOP ■]. Resume message will appear on the TV screen.

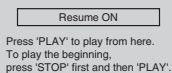

Press [PLAY ▶], playback will resume from the point at which playback was stopped. <Example : DVD>

Hint

- To cancel resume, press [STOP ■] one more time during the stop mode.
- For MP3/WMA, playback will resume from the beginning of the track at which playback was stopped.
- The resume information will be kept even when the power is turned off.
- Some Video CDs with the PBC function resume playback from the beginning of the track.

Paused and Step-by-Step Playback



Press [PAUSE ■] during playback. To continue playback, press [PLAY ▶].



The disc goes forward by one frame each time [PAUSE ■] is pressed during the pause mode. To continue playback, press [PLAY ▶].

Hint

- On DVDs, set "STILL MODE" to "FIELD" in the Display menu if pictures in the pause mode are blurred. (Refer to pages 14-15.)

Fast Forward/Reverse Search



Press [FWD ▶▶] or [REV ◀◀] repeatedly during playback to select the required forward or reverse speed.

To continue playback, press [PLAY ▶].

Hint

- For DVDs, fast forward or reverse search speed is different depending on the disc. Approximate speed is 1(x2), 2(x8), 3(x20), 4(x50) and 5(x100).
- For Audio CDs, Video CDs and MP3/WMA, approximate speed is 1(x2), 2(x8) and 3(x30).

Slow Forward/Reverse



Press [FWD ▶▶] or [REV ◀◀] repeatedly during the pause mode to select the required forward or reverse speed.

To continue playback, press [PLAY ▶].

Hint

- Slow forward or reverse speed is different depending on the disc. Approximate speed is 1(1/16), 2(1/8) and 3(1/2).
- Set "STILL MODE" to "FIELD" in the Display menu if pictures in the slow playback mode are blurred. (Refer to pages 14-15.)
- Only slow forward is available when playing Video CD.

Zoom



Press [ZOOM] repeatedly during playback to select the required zoom factor: x2, x4 or OFF.



Press [▲/▼/◀/▶] to slide the zoomed picture across the screen.

To exit zoom function, press [ZOOM] repeatedly to select OFF.

Hint

- Zooming function does not work while the disc menu is showing up.
- x4 zoom is not available on some discs.
- The picture may be distorted when you press [PAUSE ■] or [REV ◀◀] repeatedly in the zoom mode.
- It may take several seconds to slide the zoomed picture.
- Only x2 zoom is available on Video CDs.

MP3/WMA Playback

MP3/WMA is a method of compressing files. You can copy MP3/WMA files on CD-R/RWs from the computer and play the files on this unit.



Insert an MP3/WMA-format disc, then press [MENU] to call up the file list on the TV screen.

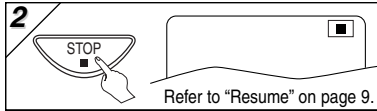
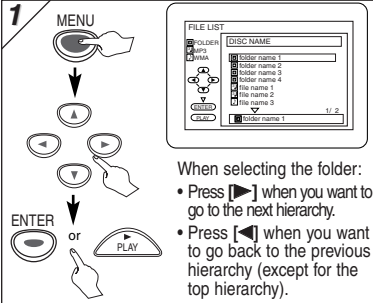

Hint

- Some selections may take a while to be recognized.
- Press [TOP MENU] to return to the first item.
- Folders are known as Groups; files are known as Tracks.
- MP3 files are accompanied by [M] icon. • WMA files are accompanied by [W] icon.
- Folders are accompanied by [F] icon.
- A maximum of 255 folders can be recognized.
- A maximum of 999 files can be recognized.
- Up to 8 hierarchies can be recognized.

This player recommends the files recorded under the following circumstances:

- Sampling frequency: 44.1kHz or 48kHz (MP3/WMA)
- Constant bit rate: 32kbps ~ 320kbps (MP3), 48kbps ~ 192kbps (WMA).
- For MP3/WMA file recorded in Variable Bit Rate (VBR), the unit may not display the actual elapsed time.
- Copyright protected WMA files will not play on this unit.

On-Screen Display

You can check the information about the current disc by pressing [DISPLAY] on the remote control.

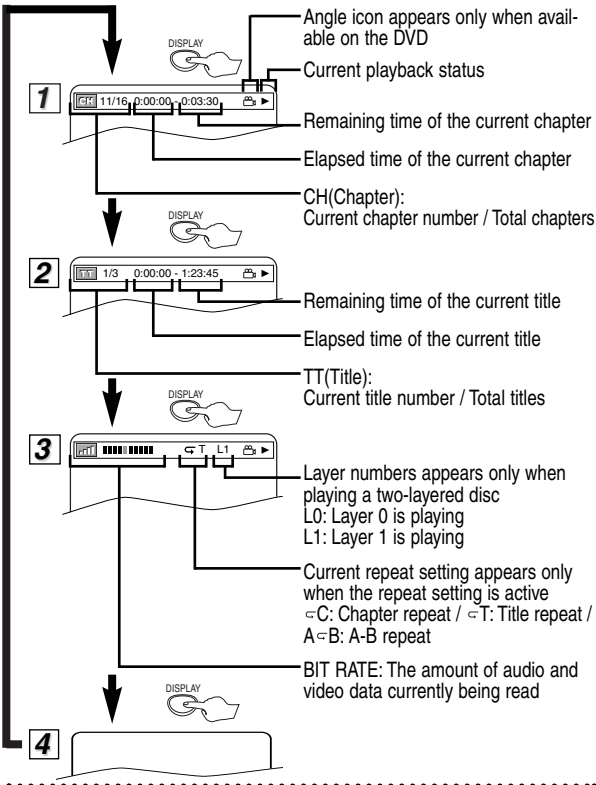

NOTE: For WMA files, **1-A** and **1-B** will be displayed after **1**.

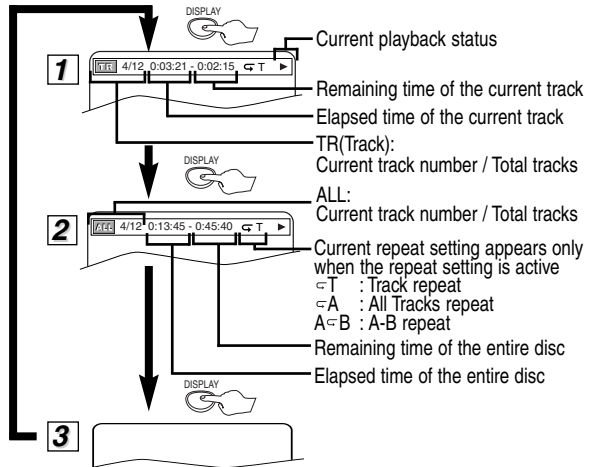
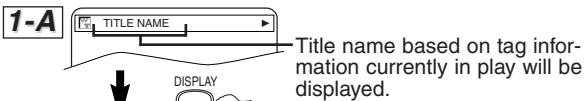

Hint

- For the Audio CDs, When you are playing a disc in PROGRAM or RANDOM mode, [TR] PROGRAM (or RANDOM) will be displayed instead of **2**.
- [TR] PBC is displayed when you play the Video CD with PBC function.

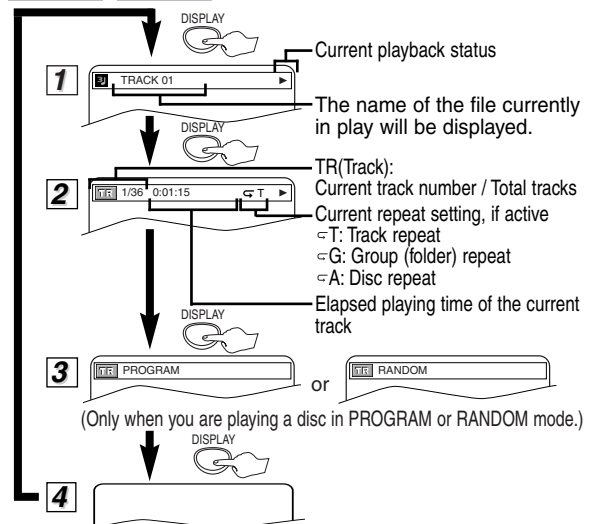

Search Function

Track Search



Using [SEARCH MODE]

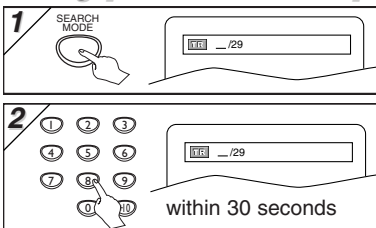

- For the disc with less than 10 tracks, press the track number directly.
- For discs with more than 10 but less than 99 tracks, to play single-digit track, press [0] first, then the track number (e.g. for track 3, press [0], [3]). To play a double-digit track, press the track number.
- For discs with more than 100 tracks, to play a single or a double-digit track, press [0] first, then the track number (e.g. for track 3, press [0], [0], [3]), and for track 26, press [0], [2], [6]). To play a triple-digit track, press the track number.

Using [SKIP ◀◀ , ▶▶]

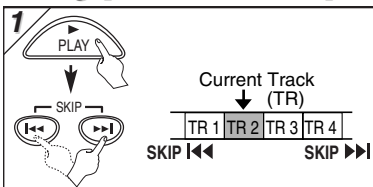

Hint

- [+10] button can also bring the Track Search display, except for the disc with less than 10 tracks. For such a disc, track search can be done by just pressing the track number.
- For Audio CDs and MP3/WMA, Track Search is not available for Programmed or Random Playback.
- Track Search is not available when you play the Video CD with PBC function.

Title / Chapter Search



Using [SEARCH MODE]

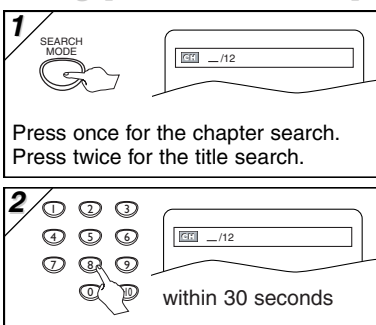

Using [SKIP ◀◀ , ▶▶]

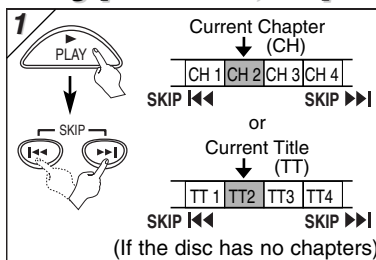

Hint

- Depending on the disc being played, this function can also be performed by directly entering the desired chapter number with the **Number buttons**. Refer to the manual accompanying the disc.

Time Search

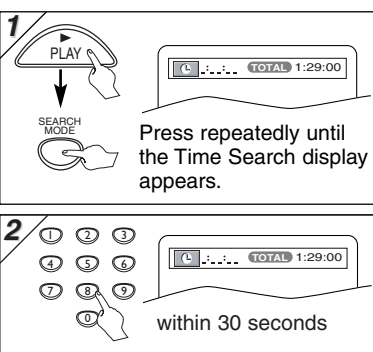

Hint

- When there is no need to enter a number, "0" appears automatically. For example, "0 : 0 : ..." appears in the Time Search display if the total time of the title or track is less than 10 minutes.
- Press [CLEAR] to erase the incorrect input at step 2.
- Time Search is not available when you play the Video CD with PBC function.

Marker Setup



This feature allows you to assign a specific point on a disc to be called back later.

To set a marker

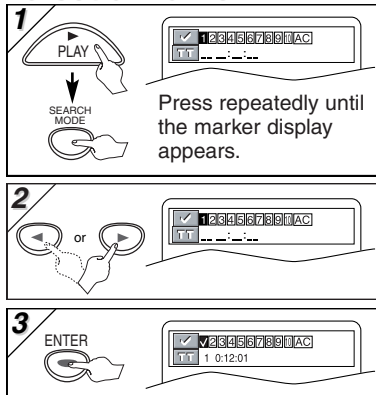

To return to the marker later

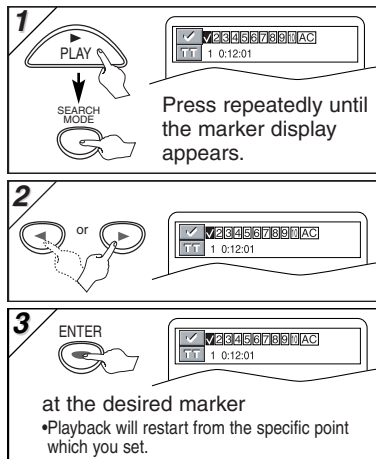

To exit the marker display

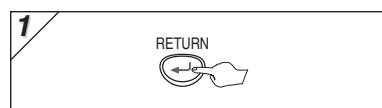

Hint

- The Marker display will disappear in about 30 seconds when there is no output.
- To clear a marker, select the marker to be cleared at step 2 in the section "To set a marker" or "To return to the marker later" and then press [CLEAR].
- Removing the disc or turning off the power will erase all markers.
- Selecting "AC" at step 2 in the section "To set a marker" or "To return to the marker later" will also erase all markers.
- Marker Setup is not available when you play the Video CD with PBC function.

Repeat / Random / Programmed Playback

Repeat Playback



Repeat function is available only during playback.

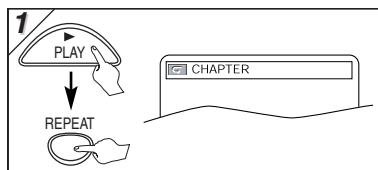

Each time you press **[REPEAT]**, repeat function changes as example below.

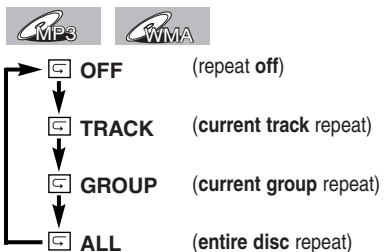
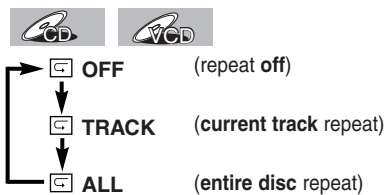
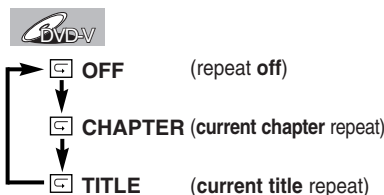

Hint

- Repeat setting will be cleared when moving to another title, chapter, track or group.
- Repeat playback may not function with some discs or during repeat A-B playback.
- Repeat playback is not available when you play the Video CD with PBC function.

Repeat A-B Playback

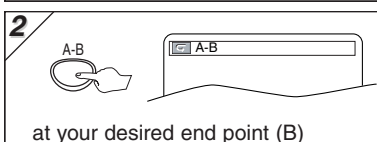
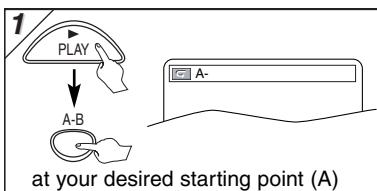

- Point B should be in the same title or track as point A.

Hint

- To exit the sequence, press **[A-B]** so that OFF appears.
- To cancel Point A, press **[CLEAR]** at step 1.
- This function does not work in the other repeat modes.

Random Playback

This function shuffles the playing order of tracks instead of playback in the sequence.

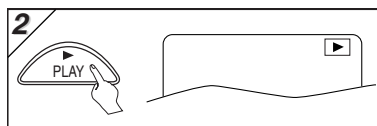
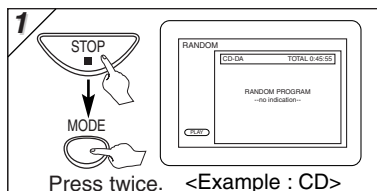

Hint

- To repeat the current track in the random selections, press **[REPEAT]** repeatedly until **[] TRACK** appears during playback.
- To repeat the entire random selections, press **[REPEAT]** repeatedly until **[] ALL** appears during playback.
- During random playback, you cannot go back to the previous track.

Programmed Playback



You may determine the order in which tracks will play.

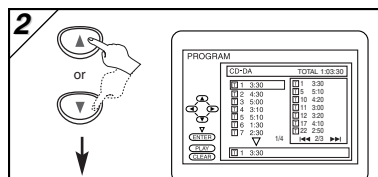
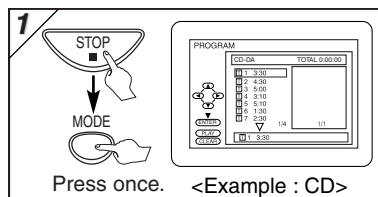

- Up to 99 tracks can be ordered.
- If eight or more tracks were in a program, use **[SKIP <<]**, **[SKIP >>]** to see all the tracks.
- While an MP3/WMA folder is open:
 - Press **[]** when you want to go to the next hierarchy.
 - Press **[]** when you want to go back to the previous hierarchy (except for the top hierarchy).

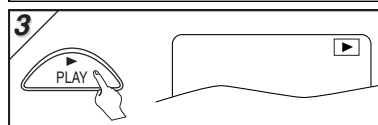

Hint

- Press **[CLEAR]** at step 2 to erase the most recently entered track.
- To erase all programmed tracks at once, select "ALL CLEAR" and press **[ENTER]** at step 2.
- While a program is being played back, **[STOP ■]** works as follows;
 - ⇒ Press **[STOP ■]** and **[PLAY ►]** next, so that the programmed playback restarts. (CD playback restarts from the current point. MP3/WMA playback restarts from the beginning of the current track.)
 - ⇒ Press **[STOP ■]** twice and **[PLAY ►]** next, so that playback restarts from the first track in the original order. However, your programmed playback can be restarted when you follow the above steps. (Your programs are still stored until either the disc is removed or power is turned off.)
- To repeat the current track in the program, press **[REPEAT]** repeatedly until **[] TRACK** appears during playback.
- To repeat the entire program, press **[REPEAT]** repeatedly until **[] ALL** appears during playback.

Special Settings

Subtitle Language



This unit allows you to select a subtitle language (if available) during DVD playback.

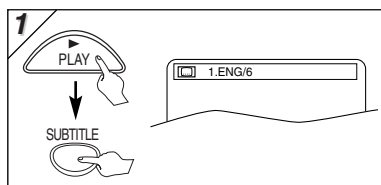

Each time you press **[SUBTITLE]**, subtitle language changes as example below.

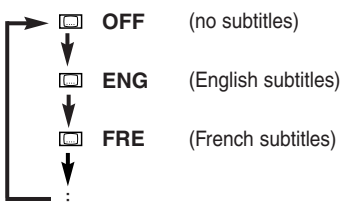

To set subtitle ON/OFF

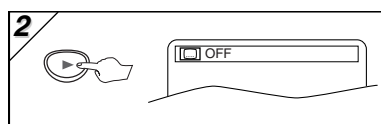
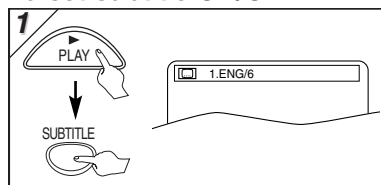

Hint

- If your language is not shown after pressing **[SUBTITLE]** several times, the disc may not have that language. However, some discs allow subtitle language setting on the disc menu. (Operation varies depending on the disc, so refer to the manual along with the disc.)
- When "NOT AVAILABLE" appears on the TV screen, it means no subtitle is recorded on the scene.
- If you choose a language that has three-letter-language code, the code will be displayed every time you change the subtitle language setting. If you choose any other languages, '---' will be displayed instead. (Refer to page 18.)
- Some discs will only allow you to change the subtitle from the disc menu. Refer to the manual accompanying the discs for details.

Audio Language



This unit allows you to select an audio language (if multiple languages are available on disc) during DVD playback.

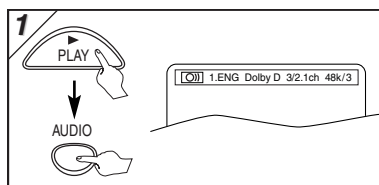

Each time you press **[AUDIO]**, audio language changes as example below.



Hint

- Some discs will only allow you to change the audio setting from the disc menu. Refer to the manual accompanying the discs for details.
- If your language is not shown after pressing **[AUDIO]** several times, the disc may not have that language. However, some disc allow audio language setting on the disc menu. (Operation varies depending on the disc, so refer to the manual along with the disc.)

Camera Angles



Some DVD discs may contain scenes which have been shot simultaneously from various angles. You can change the camera angle if the (ANGLE ICON) icon appears on the screen. If the "ANGLE ICON" setting is "OFF" in the OTHERS menu, the (ANGLE ICON) icon will not appear. (Refer to pages 14-16.)

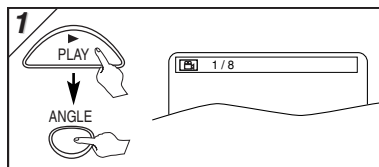

Black Level Setting



Adjust the Black Level Setting to make the dark areas of the TV picture brighter.

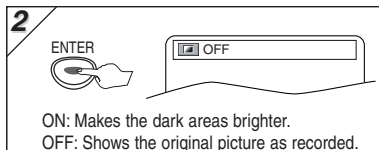
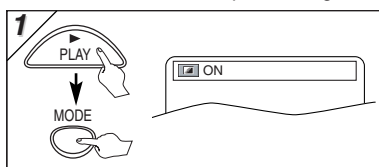

ON: Makes the dark areas brighter.
OFF: Shows the original picture as recorded.

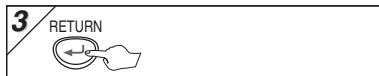

Stereo Sound Mode



This unit allows you to select a sound mode during CD playback.

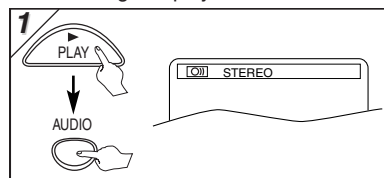

Each time you press **[AUDIO]**, sound mode changes as example below.

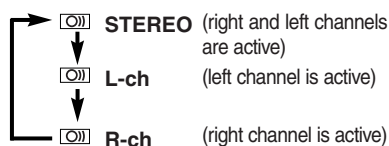

Virtual Surround



You can enjoy stereophonic virtual world on your existing 2 channel stereo system.

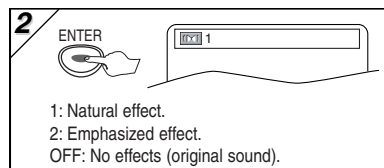
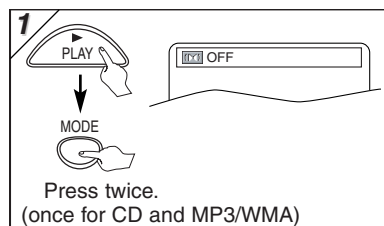

1: Natural effect.
2: Emphasized effect.
OFF: No effects (original sound).



Hint

For CD playback only

- Virtual Surround will not be effective if the sound mode is set to something other than STEREO. Refer to "Stereo Sound Mode".
- When playing back a 96kHz with Virtual Surround function, the sound will be down sampling at 48kHz and output as digital audio.

DVD Setup

QUICK SETUP Menu

You can select the "PLAYER MENU", "TV ASPECT" or "DOLBY DIGITAL" from the QUICK SETUP menu quickly.

1

<SETUP MENU>
Confirm that "QUICK" is selected.

2

Select the desired item.

ENTER

- P14 **A** Step 5
- P15 **B** Step 5
- P15 **C** Step 5

ENTER

• Refer to the sections "PLAYER MENU", "TV ASPECT" or "DOLBY DIGITAL" on page 14 or 15.

CUSTOM Menu

You can change the settings of the unit.

• **QUICK** on pages 14-15 indicates DVD Setup menus also accessible from the QUICK SETUP menu.

1

<SETUP MENU>

2

Select "CUSTOM".

ENTER

3

Select the desired item.

LANGUAGE menu → page 14 **A**

DISPLAY menu → page 15 **B**

AUDIO menu → page 15 **C**

PARENTAL menu → page 16 **D**

OTHERS menu → page 16 **E**

A LANGUAGE Setting

Follow steps 1 to 3 in the "CUSTOM Menu" section above.

4 Select the desired item.

ENTER

LANGUAGE menu

5 Select the desired language.

ENTER

AUDIO: *1 *2
(Default: ORIGINAL)
Sets the audio language.

SUBTITLE: *1 *2
(Default: OFF)
Sets the subtitle language.

DISC MENU: *1
(Default: ENGLISH)
Sets the language in DVD menu.

PLAYER MENU: QUICK
(Default: ENGLISH)
Sets the language for the On-Screen Display.

6 To exit the menu

SETUP

Hint

*1

- Language options are not available with some discs.
- If OTHER is selected in the AUDIO, SUBTITLE or DISC MENU screen, press four-digit number to enter the code for the desired language. (Refer to the language code list on page 18.)
- Only the languages supported by the disc can be selected.

*2

- Language setting for Audio and Subtitle are not available with some discs. Then press **[AUDIO]** and **[SUBTITLE]**. Details are on page 13.

B DISPLAY Setting

You can change the display functions. Follow steps 1 to 3 in the "CUSTOM Menu" section on page 14.

4 Select the desired item.

5

TV ASPECT: QUICK
(Default: 4:3 LETTER BOX)
See Hint on the right.

TV ASPECT: 4:3 LETTERBOX / STILL MODE AUTO → TV ASPECT: 4:3 LETTERBOX / 4:3 PAN & SCAN / 16:9 WIDE → Select the desired setting. → ENTER

STILL MODE:
(Default: AUTO)
See Hint on the right.

TV ASPECT: 4:3 LETTERBOX / STILL MODE AUTO → STILL MODE: AUTO / FIELD / FRAME → Select the desired setting. → ENTER

6 To exit the menu
SETUP

Hint

TV ASPECT:

- Select "4:3 LETTER BOX", so that black bars may appear on the top and bottom of the screen.
- Select "4:3 PAN & SCAN" for a full height picture with both sides adjusted.
- Select "16:9 WIDE" if a wide-screen TV is connected to this unit.

STILL MODE:

- Select "AUTO" usually.
- If you select AUTO, automatically select the best resolution setting (FRAME or FIELD) based on the data characteristics of the pictures. (default).
- If you select "FIELD", the picture in the still mode will be stabilized.
- If you select "FRAME", the picture in the still mode will be highly defined.
- An individual picture on TV screen is called a "frame", which consists of two separate images called a "field". Some pictures may be blurred at the AUTO setting in the still mode due to their data characteristics.

C AUDIO Setting

Choose the appropriate audio settings for your equipments. It only affects during the playback of DVD discs. Follow steps 1 to 3 in the "CUSTOM Menu" section on page 14.

4 Select the desired item.

5

DRC (Dynamic Range Control):
(Default: ON)
Set to "ON" to compress the range between soft and loud sounds.

DRC: ON / DOWN SAMPLING ON / DOLBY DIGITAL BITSTREAM → DRC: OFF / DOWN SAMPLING ON / DOLBY DIGITAL BITSTREAM → ENTER

DOWN SAMPLING:
(Default: ON)
Set to "ON" when outputting in 48kHz.
Set to "OFF" when outputting the original sound.

DRC: ON / DOWN SAMPLING ON / DOLBY DIGITAL BITSTREAM → DOWN SAMPLING: ON / OFF / BITSTREAM → ENTER

DOLBY DIGITAL: QUICK
(Default: BITSTREAM)
Set to "BITSTREAM" when the unit is connected to a Dolby Digital receiver.

- BITSTREAM: Outputs a Dolby Digital Signals.
- PCM: Convert the Dolby Digital into PCM (2 channel).

DRC: ON / DOWN SAMPLING ON / DOLBY DIGITAL BITSTREAM → DOLBY DIGITAL: ON / ON / PCM → ENTER

6 To exit the menu
SETUP

Hint

DRC:

- This function is available only on the discs which are recorded in the Dolby Digital format.

DOWN SAMPLING:

- When playing disc with copyright protection, the sound will be down sampled at 48kHz, even if you set to OFF.
- **This function is available only on digital outputting of a disc recorded in 96kHz.**

D PARENTAL Setting

Parental Control limits the disc viewing that exceed your settings. (An incorrect password will not be acceptable.) This feature prevents your children from viewing inappropriate materials.

Parental Levels

Parental Level allows you to set the rating levels of your DVD discs. Playback will stop if the ratings exceed the levels you set. Follow steps 1 to 3 in the "CUSTOM Menu" section on page 14.

4 Enter your desired four-digit password.

PARENTAL menu

..... OR
If you have set a password already, enter the current four-digit password.

5 Select "PARENTAL LEVEL".

PARENTAL LEVEL ALL PASSWORD CHANGE

6 Select the desired level.

PARENTAL LEVEL
ALL
8
7 [NC-17]
6 [R]

7 To exit the menu

SETUP

CONTROL LEVELS

- ALL: All parental locks are cancelled.
- Level 8: DVD softwares of any grades (adult/general/children) can be played back.
- Levels 7 to 2: Only DVD softwares intended for general use and children can be played back.
- Level 1: Only DVD softwares intended for children can be played back, with those intended for adult and general use prohibited.

TIPS FOR LEVELS

- 7 [NC-17]: No one under 17 admitted
- 6 [R]: Restricted; under 17 requires accompanying parent or adult guardian
- 4 [PG13]: Unsuitable for children under 13
- 3 [PG]: Parental Guidance suggested
- 1 [G]: General Audience

Hint

- DVD-Video discs may not respond to the parental lock settings. Make sure this function works with your DVD-Video discs.

To Change the Password for Parental Controls

You can change your password for parental controls. Follow steps 1 to 3 in the "CUSTOM Menu" section on page 14.

4 Enter current four-digit password.

PARENTAL menu

5 Select "PASSWORD CHANGE".

PARENTAL LEVEL ALL PASSWORD CHANGE

6 Enter your new four-digit password (except for 4737).

PARENTAL menu

7 To exit the menu

SETUP

Hint

- Record the password in case you forget it.
- If you forget the password, press [4], [7], [3], [7] at step 4, then enter your new password. Password will be cleared and parental levels will be set to "ALL".

E OTHERS Setting

You can change the other functions. Follow steps 1 to 3 in the "CUSTOM Menu" section on page 14.

4 Select the desired item.

OTHERS menu

5

ANGLE ICON:
(Default: ON)
Set to "ON" to show the angle icon when multiple camera angles are available during DVD playback.

ANGLE ICON ON OFF
AUTO POWER OFF ON ON

ENTER

AUTO POWER OFF:
(Default: ON)
Set to "ON" to turn this unit off automatically after 30 minutes of no use.

ANGLE ICON ON ON
AUTO POWER OFF ON OFF

ENTER

6 To exit the menu

SETUP

Reset to the Default Setting (Except for PARENTAL Setting)

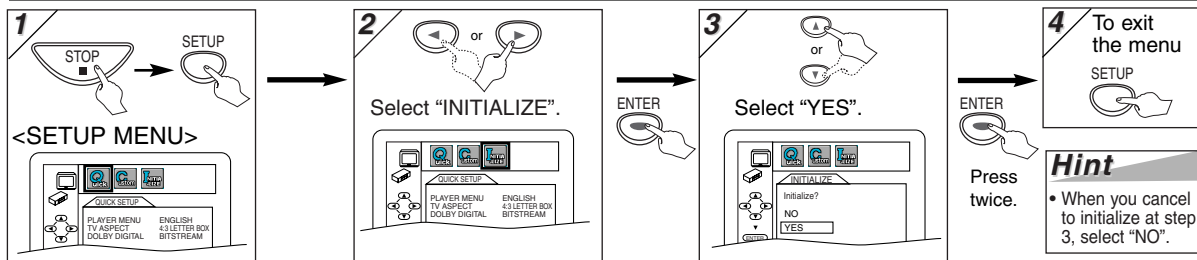

Information

Troubleshooting Guide

If the unit does not perform properly when operated as instructed in this Owner's Manual, check the unit consulting the following checklist.

Problem	Solution
No power	<ul style="list-style-type: none"> –Check if the AC power cord is properly connected. –Unplug the outlet once, and wait for 5-10 seconds and then plug it in again.
No sound or picture	<ul style="list-style-type: none"> –Check if the TV is switched on. –Check the video connection. –Check the VIDEO/AUDIO cable connections to the TV. (See "Connection to a TV".)
Distorted picture	<ul style="list-style-type: none"> –Sometimes a small amount of picture distortion may appear. This is not a malfunction. –Connect the unit directly to the TV.
Completely distorted picture or black/white picture with DVD	<ul style="list-style-type: none"> –Connect the unit directly to the TV. –Make sure the disc is compatible with the unit.
No sound or distorted sound	<ul style="list-style-type: none"> –Adjust the volume. –Check that the speakers are connected correctly.
No audio at digital output	<ul style="list-style-type: none"> –Check the digital connections. –Check if the audio format of the selected audio language matches your receiver capabilities.
No DTS audio is output	<ul style="list-style-type: none"> –This unit does not support DTS audio. This is not a malfunction.
Picture freezes momentarily during playback	<ul style="list-style-type: none"> –Check the disc for fingerprints/scratches and clean with a soft cloth wiping from center to edge. –Clean the disc.
Disc can't be played	<ul style="list-style-type: none"> –Clean the disc. –Ensure the disc is inserted in correct direction. –Check if the disc is defective by trying another disc. –Cancel the parental lock or change the control level. –Insert a correct disc that plays on this unit. –Handle a disc with special care so that it does not have fingerprints, scratches, or dusts on its surface.
No return to start-up screen when disc is removed	<ul style="list-style-type: none"> –Reset the unit by switching the unit off, then on again.
The unit does not respond to the remote control	<ul style="list-style-type: none"> –Aim the remote control directly at the sensor on the front of the unit. –Reduce the distance to the unit. –Replace the batteries in the remote control. –Re-insert the batteries with their polarities (+/- signs) as indicated. –Tune your radio to an empty AM station so that you hear a lot of noises. Then, turn the volume up. If you hear some signal sound from the radio by pressing buttons on the remote control, the remote control is working.
Buttons do not work or the unit stops responding	<ul style="list-style-type: none"> –To completely reset the unit, unplug the AC cord from the AC outlet for 5-10 seconds.
The unit does not respond to some operating commands during playback	<ul style="list-style-type: none"> –Operations may not be permitted by the disc. Refer to the instructions of the disc.
The unit cannot read CDs/DVDs	<ul style="list-style-type: none"> –Use a commonly available cleaning CD/DVD to clean the lens before sending the unit for repair.
Angle does not switch	<ul style="list-style-type: none"> –The angle cannot be switched for DVDs which do not contain multiple angles. In some cases multiple angles are only recorded for specific scenes.
Playback does not start when the title is selected	<ul style="list-style-type: none"> –Check the "PARENTAL" setting.
The password for rating level has been forgotten	<ul style="list-style-type: none"> –Enter the default password "4737", then your forgotten password will be cleared.
Disc cannot be inserted	<ul style="list-style-type: none"> –Check if any disc is already in.
Disc cannot be taken out	<ul style="list-style-type: none"> –Press and hold [EJECT ▲] on the unit for more than 5 seconds.

NOTES:

- Some functions are not available in specific modes, but this is not a malfunction. Read the description in this Owner's Manual for more details on correct operations.
- Playback from a desired track and random playback are not available during program playback.
- Some functions are prohibited on some discs.
- When playing Video CDs with PBC function, some operations (e.g., select and track repeat) cannot be performed.

Specifications

DVD/CD player unit :

Output signal format:

NTSC color

Power source:

120 V AC +/- 10%,

60 Hz +/- 0.5%

Power consumption:

10 W (standby: 0.8 W)

Operating temperature:

41°F (5°C) to 104°F (40°C)

Dimensions:

W : 10" (255 mm)

H : 2 1/16" (59 mm)

D : 9 9/16" (243.5 mm)

Weight :

Approx 2.9 lbs (1.3 kg)

Supplied speaker unit :

Dimensions:

W : 2 13/16" (70 mm)

H : 9 6/8" (247 mm)

D : 4 3/8" (110 mm)

Weight :

Approx 0.5 lbs (0.2 kg)

Sound output:

3W, 4 Ω x 2

• Designs and specifications are subject to change without notice.

• If there is a discrepancy between languages, the default language will be English.

Language Code List

Language	Code	Language	Code	Language	Code	Language	Code
Abkhazian	A-B	French [FRE]	5264	Macedonian	5957	Siswat	6565
Afar	4747	Frisian	5271	Malagasy	5953	Slovak	6557
Afrikaans	4752	Galician	5358	Malay	5965	Slovenian	6558
Albanian	6563	Georgian	5747	Malayalam	5958	Somali	6561
Amharic	4759	German [GER]	5051	Maltese	5966	Spanish [SPA]	5165
Arabic	4764	Greek [GRE]	5158	Maori	5955	Sundanese	6567
Armenian	5471	Greenlandic	5758	Marathi	5964	Swahili	6569
Assamese	4765	Guarani	5360	Moldavian	5961	Swedish [SWE]	6568
Aymara	4771	Gujarati	5367	Mongolian	5960		
Azerbaijani	4772	Hausa	5447	Nauru	6047	Tagalog	6658
Bashkir	4847	Hebrew	5569	Nepali	6051	Tajik	6653
Basque	5167	Hindi	5455	Norwegian [NOR]	6061	Tamil	6647
Bengali; Bangla	4860	Hungarian [HUN]	5467			Tatar	6666
Bhutani	5072			Occitan	6149	Telugu	6651
Bihari	4854	Icelandic [ICE]	5565	Oriya	6164	Thai	6654
Bislama	4855	Indonesian	5560	Oromo (Afan)	6159	Tibetan	4861
Breton	4864	Interlingua	5547	Panjabi	6247	Tigrinya	6655
Bulgarian	4853	Interlingue	5551	Pashto; Pushto	6265	Tonga	6661
Burmese	5971	Inupiak	5557	Persian	5247	Tsonga	6665
Byelorussian	4851	Irish [IRI]	5347	Polish	6258	Turkish [TUR]	6664
		Italian [ITA]	5566	Portuguese [POR]	6266	Turkmen	6657
		Japanese [JPN]	5647	Quechua	6367	Twi	6669
Cambodian	C-E	Javanese	5669	Rhaeto-Romance	6459		
Catalan	4947	Kannada	5760	Romanian [RUM]	6461	Ukrainian	6757
Chinese [CHI]	7254	Kashmiri	5765	Russian [RUS]	6467	Urdu	6764
Corsican	4961	Kazakh	5757			Uzbek	6772
Croatian	5464	Kinyarwanda	6469	Samoan	6559	Vietnamese	6855
Czech	4965	Kirghiz	5771	Sangho	6553	Volapuk	6861
Danish [DAN]	5047	Kirundi	6460	Sanskrit	6547	Welsh	4971
Dutch [DUT]	6058	Korean [KOR]	5761	Scots Gaelic	5350	Wolof	6961
English [ENG]	5160	Kurdish	5767	Serbian	6564	Xhosa	7054
Esperanto	5161			Serbo-Croatian	6554	Yiddish	6555
Estonian	5166	Laothian	L-N	Sesotho	6566	Yoruba	7161
		Latin	5847	Setswana	6660	Zulu	7267
Faroese	F-H	Latvian; Lettish	5868	Shona	6560		
Fiji	5256	Lingala	5860	Sindhi	6550		
Finnish [FIN]	5255	Lithuanian	5866	Singhalese	6555		

If you choose a Language that has a 3 letter language code, the code will be displayed every time you change the Audio or Subtitle language setting on page 13. If you choose any other languages, '---' will be displayed instead. (3 letter language code is written in bracket.)

Symphonic Limited Warranty

FUNAI CORP. will repair this product, free of charge in the USA in the event of defect in materials or workmanship as follows:

DURATION:

PARTS: FUNAI CORP. will provide parts to replace defective parts without charge for one (1) year from the date of original retail purchase. Certain parts are excluded from this warranty.

LABOR: FUNAI CORP. will provide the labor without charge for a period of ninety (90) days from the date of original retail purchase.

LIMITS AND EXCLUSIONS:

This warranty is extended only to the original retail purchaser. A purchase receipt or other proof of original retail purchase will be required together with the product to obtain service under this warranty.

This warranty shall not be extended to any other person or transferee.

This warranty is void and of no effect if any serial numbers on the product are altered, replaced, defaced, missing or if service was attempted by an unauthorized service center. This limited warranty does not apply to any product not purchased and used in the United States.

This product is produced for home use and this warranty only covers failures due to defects in material or workmanship which occurs during normal use. It does not cover damage which occurs in shipment, or failures which are caused by repairs, alterations or product not supplied by FUNAI CORP., or damage which results from accident, misuse, abuse, mishandling, misapplication, alteration, faulty installation, improper maintenance, commercial use such as hotel, rental or office use of this product or damage which results from fire, flood, lightning or other acts of God.

THIS WARRANTY DOES NOT COVER PACKING MATERIALS, ANY ACCESSORIES (EXCEPT REMOTE CONTROL), ANY COSMETIC PARTS, COMPLETE ASSEMBLY PARTS, DEMO OR FLOOR MODELS. FUNAI CORP. AND ITS REPRESENTATIVES OR AGENTS SHALL

IN NO EVENT BE LIABLE FOR ANY GENERAL, INDIRECT OR CONSEQUENTIAL DAMAGES ARISING OUT OF OR OCCASIONED BY THE USE OF OR THE INABILITY TO USE THIS PRODUCT. THIS WARRANTY IS MADE IN LIEU OF ALL OTHER WARRANTIES, EXPRESS OR IMPLIED, AND OF ALL OTHER LIABILITIES ON THE PART OF FUNAI, ALL OTHER WARRANTIES INCLUDING THE WARRANTY OF MERCHANTABILITY, AND FITNESS FOR A PARTICULAR PURPOSE, ARE HEREBY DISCLAIMED BY FUNAI AND ITS REPRESENTATIVES IN THE UNITED STATES. ALL WARRANTY INSPECTIONS AND REPAIRS MUST BE PERFORMED BY AN AUTHORIZED SERVICE CENTER. THIS WARRANTY IS VALID WHEN THE UNIT IS CARRIED-IN TO AN AUTHORIZED SERVICE CENTER.

IMPORTANT:

THIS LIMITED WARRANTY GIVES YOU SPECIFIC LEGAL RIGHTS. YOU MAY HAVE OTHER RIGHTS THAT VARY FROM STATE TO STATE. IF, AT ANY TIME DURING THE WARRANTY PERIOD, YOU ARE UNABLE TO OBTAIN SATISFACTION WITH THE REPAIR OF THIS PRODUCT, PLEASE CONTACT FUNAI CORP.

ATTENTION:

FUNAI CORP. RESERVES THE RIGHT TO MODIFY ANY DESIGN OF THIS PRODUCT WITHOUT PRIOR NOTICE.

To locate your nearest AUTHORIZED SERVICE CENTER or for general service inquiries, please contact us at:

FUNAI CORPORATION
Customer Service

Tel :1-800-242-7158

<http://www.Symphonic.us>

19900 Van Ness Avenue, Torrance, CA 90501

1 Conexiones

Si su televisor tiene entradas de AUDIO/VIDEO vea la sección "Connection to a TV" en la página 6 en el Manual de Manejo. En caso contrario, vea la sección "Connection to RF Modulator" en la página 6 en el Manual de Manejo.

2 Instalación de las pilas en el control remoto

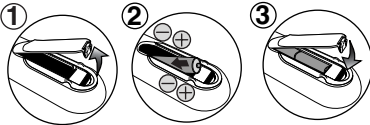

3 Para cambiar el idioma en la pantalla

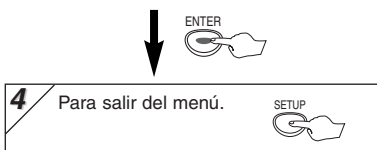
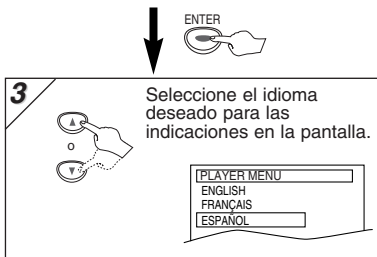
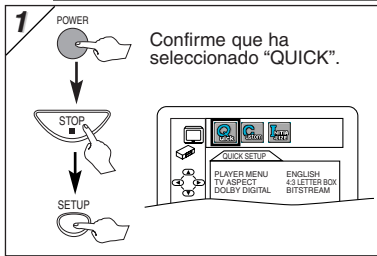

4 Reproducción

Antes:

- Encienda el televisor, amplificador y otros equipos conectados a esta unidad. Asegúrese que el televisor y el sintonizador de audio (de venta en los comercios) están en el canal correcto.

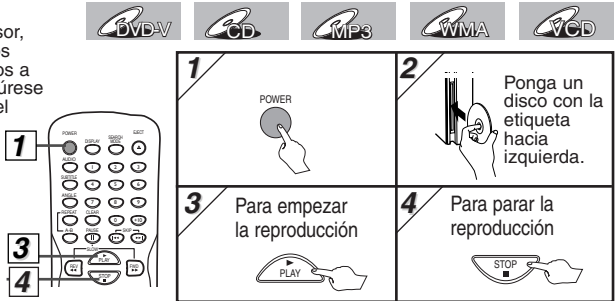

5 Control remoto

Button (Alphabetical order)	Disc	DVD	CD	MP3	WMA	VCD
1 2 3 4 5 6 7 8 9 0		• Para seleccionar directamente el capítulo o título.	• Para seleccionar directamente la canción.			
ENTER		• Para mover el cursor y determinar la posición.	• Para mover el cursor y determinar la posición.			
A-B		• Para repetir entre su punto A y B seleccionado.	• Para repetir entre su punto A y B seleccionado. (CD/VCD)			
ANGLE		• Para seleccionar los ángulos de cámara en un disco.	—			
AUDIO		• Para seleccionar idiomas de audio en un disco.	• Para seleccionar ESTÉREO L-ch o R-ch. (CD/VCD)			
CLEAR		• Para borrar los marcadores. • Para borrar los números mal entrados. • Para borrar el punto para la repetición A-B.	• Para borrar los marcadores. (CD/VCD) • Para eliminar el N° de estado en la entrada de programa. • Para borrar los números mal entrados. • Para borrar el punto para la repetición A-B. (CD/VCD)			
DISPLAY		• Para mostrar el modo de disco actual.	• Para mostrar el modo de disco actual.			
EJECT		• Para remover el disco de la unidad.	• Para remover el disco de la unidad.			
REV		• Para buscar en avance/retroceso por un disco. • Para empezar la reproducción en avance lento/retroceso durante el modo de pausa.	• Para buscar en avance/retroceso por un disco • Para empezar la reproducción en avance lento durante el modo de pausa. (VCD)			
FWD		• Para buscar en avance/retroceso por un disco. • Para empezar la reproducción en avance lento/retroceso durante el modo de pausa.	• Para buscar en avance/retroceso por un disco • Para empezar la reproducción en avance lento durante el modo de pausa. (VCD)			
MENU		• Para llamar el Menú en un disco.	• Para llamar la lista de archivo. (MP3/WMA)			
MODE		• Para activar/desactivar el nivel del negro. • Para activar/desactivar el ambiental virtual.	• Para disponer el orden de reproducción o la reproducción aleatoria. (CD/MP3/WMA) • Para activar/desactivar el ambiental virtual. • Para activar/desactivar el nivel del negro. (VCD)			
PAUSE		• Para hacer una pausa en la reproducción. • Para avanzar la reproducción un cuadro cada vez.	• Para hacer una pausa en la reproducción del disco. • Para avanzar la reproducción un cuadro a la vez. (VCD)			
PLAY		• Para empezar la reproducción del disco.	• Para empezar la reproducción del disco.			
POWER		• Para encender o apagar la unidad.	• Para encender o apagar la unidad.			
REPEAT		• Para reproducir repetidamente un capítulo o título.	• Para reproducir repetidamente una canción o disco. (CD/VCD) • Para reproducir repetidamente una canción, grupo o disco. (MP3/WMA)			
RETURN		• Para volver a la operación anterior en el menú.	• Para volver a la operación anterior en el menú.			
SEARCH MODE		• Para buscar un capítulo, título o tiempo. • Para colocar o buscar los marcadores.	• Para buscar una canción. • Para buscar el tiempo. (CD/VCD) • Para colocar o buscar los marcadores. (CD/VCD)			
SETUP		• Para llamar el menú de ajustes de DVD.	• Para llamar el menú de ajustes de DVD.			
SKIP		• Para saltar capítulos o título.	• Para saltar canciones.			
STOP		• Para parar la reproducción.	• Para parar la reproducción.			
SUBTITLE		• Para seleccionar subtítulos en un disco.	—			
TOP MENU		• Para llamar el menú inicial en un disco.	• Para volver al archivo superior de la jerarquía más alta en el programa y en la lista de archivo. (MP3/WMA)			
ZOOM		• Para ampliar la imagen de vídeo en DVD. (x2/x4)	• Para ampliar parte de la imagen (x2). (VCD)			

Quick Use Guide

1 Connections

If your TV has AUDIO/VIDEO input jacks, see the section "Connection to a TV" on page 6 of the Owner's Manual. If not, see the section "Connection to RF Modulator" on page 6 of the Owner's Manual.

4 Playback

Before:
 • Turn on the TV, amplifier and any other equipments which are connected to this unit. Make sure the TV and audio receiver (commercially available) are set to the correct channel.

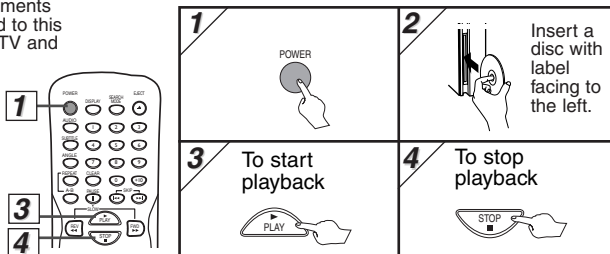

2 Installing the Batteries for the Remote Control



3 To Change the On-Screen Language

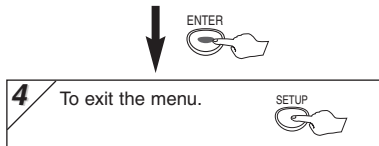
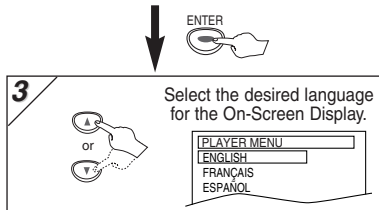
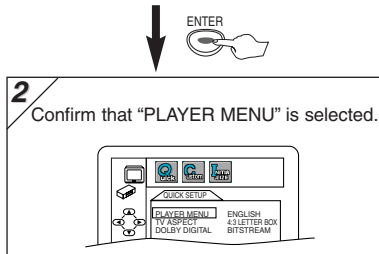
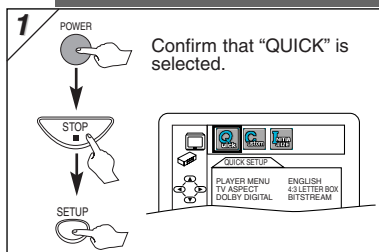

5 Remote Control

Button (Alphabetical order)	Disc	DVD-V	CD	MP3	WMA	VCD
1 2 3 4 5 6 7 8 9 0		• To select chapter or title directly.				• To select track directly.
ENTER		• To move the cursor and determine its position.				• To move the cursor and determine its position.
A-B		• To repeat between your chosen point A and B.				• To repeat between your chosen point A and B. (CD/VCD)
ANGLE		• To select camera angles on a disc.				—
AUDIO		• To select audio language on a disc.				• To select STEREO, L-ch or R-ch. (CD/VCD)
CLEAR		• To clear the markers. • To clear the numbers entered incorrectly. • To cancel the point for A-B repeat.				• To clear the markers. (CD/VCD) • To remove status number in program input. • To clear the numbers entered incorrectly. • To cancel the point for A-B repeat. (CD/VCD)
DISPLAY		• To display the current disc mode.				• To display the current disc mode.
EJECT		• Press to remove the disc.				• Press to remove the disc.
REV FWD		• To search forward/backward through a disc. • To begin slow forward/reverse playback in the pause mode.				• To search forward/backward through a disc. • To begin slow forward playback during the pause mode. (VCD)
MENU		• To call up the Menu on a disc.				• To call up the file list. (MP3/WMA)
MODE		• To set black level on/off. • To set virtual surround on/off.				• To arrange the playing order or play randomly. (CD/MP3/WMA) • To set virtual surround on/off. • To set black level on/off. (VCD)
PAUSE		• To pause disc playback. • To advance playback one frame at a time.				• To pause disc playback. • To advance playback one frame at a time. (VCD)
PLAY		• To begin disc playback.				• To begin disc playback.
POWER		• To turn the unit on/off.				• To turn the unit on/off.
REPEAT		• To play a chapter or title repeatedly.				• To play a track or disc repeatedly. (CD/VCD) • To play a track, group or disc repeatedly. (MP3/WMA)
RETURN		• To return to the previous operation in menu.				• To return to the previous operation menu.
SEARCH MODE		• To search chapter, title or time. • To set or search the markers.				• To search track. • To search time. (CD/VCD) • To set or search the markers. (CD/VCD)
SETUP		• To call up the DVD setup menu.				• To call up the DVD setup menu.
SKIP		• To skip chapters or titles.				• To skip tracks.
STOP		• To stop playback.				• To stop playback.
SUBTITLE		• To select subtitles on a disc.				—
TOP MENU		• To call up the Top Menu on a disc.				• To return to the top file of the highest hierarchy in the program and file list. (MP3/WMA)
ZOOM		• To magnify part of a picture. (x2/x4)				• To magnify part of a picture. (x2)/VCD)